



Forklift Truck
Capacity 22000 - 40000 lb
HT100Ds - HT180Ds
SERIES 1411

Linde Material Handling



Safety

Excellent all around visibility is achieved by the overall design of the new HT100Ds-HT180Ds. By positioning the cab, seat and steering in a centralized position Linde ensures superb through the mast visibility. Rear visibility is optimized by the wide rear window and unique "Clear View" rear deck. The new Armored Glass roof provides an unobstructed view of the lifted load.

Performance

A highlight of the HT100Ds-HT180Ds range is the "Power on Demand" capability which balances engine output with the truck load and application, ensuring fuel savings and reduced service costs. High productivity is delivered by the robust, quiet, reliable and fuel-efficient Detroit Diesel Engine.

Comfort

This truck delivers a comfortable and ergonomic operating environment with maximized cab space. Fully adjustable seating allows the driver to select individual seating preference and a range of options ensure that the cab can be tailored to individual customer requirements. The premium armrest is equipped with an ergonomic "rotary multi-function interface" which is connected to a 7" screen.

Reliability/Durability

The new Linde range of forklift trucks feature high quality and well-known robust and reliable components which have been thoroughly tested in numerous material handling and heavy duty, off-road applications to ensure a long operational life.

Productivity

A quiet, smooth and efficient overall driving experience is delivered via the use of powershift drive technology. Powerful acceleration and precise load handling are provided at all times, thereby assuring optimal levels of productivity. The Detroit/MTU, ZF 3 WG and Kessler drive train combination ensure outstanding performance with no interruption of the tractive effort via the use of proportional valves.

Standard and optional equipment

Standard Equipment

Cabin, Doors & Heater	Standard armrest
Adjustable steering column	7" High Resolution Color LCD Display
Orange seat belt, with interlock	Audible warning reverse alarm
USB charging port	Detroit MTU 4R1000 T4F at 173 HP or 201 HP diesel engine (depending on the truck model)
Armored glass "Clear Sky View"	Main air cleaner with integral safety element
External mirrors	ZF 3 WG 161 ERGOPOWER SERIES (HT120D-HT160D) Trans.
Abundant storage space	ZF 3 WG 131 ERGOPOWER SERIES (HT100D only) Trans.
Dual hour meters	Kessler D81 drive axle
12V socket in cabin	Variable displacement piston pump for working hydraulics
Master engine shut-off	Digital, proportional valve with integrated safety monitor
Internal rear-view mirror	High-performance hydraulic filter preserving max. purity of oil for long life of all hydraulic components
Lockable, underseat storage box	Integral SS/FP carriages
Single drive pedal with direction selector in armrest	Fork carriage, width b3 = 100 in
Hydraulic-suspension comfort-class seat	Pneumatic tires
Individual levers - forkspread and sideshift	S & D masts
Linde Load Control for low-effort precision control of all mast functions	Linde Service Monitoring System (SMS) incl. total engine hours, idle time, static working hours and mobile working hours
Powered tilting cabin	

Optional Equipment

Tinted glass	Working lights + LED
Heated glass	Road light package
Panoramic internal mirrors	Warning Beacons
Extra seat	Remote (Modem) diagnostics
10° or 17° rotating driver's seat	Mast height slowdown/speed limit
DIN A4 writing pad - Linde (illuminated)	Connect Access Control
Cup Holder(s)	Digital audio broadcasting radio with MP3, USB, Bluetooth and speakers (waiver required)
Climate Control System (Heat/AC)	Detroit MTU 4R 1000 T4 available 228 HP power rating
Sun blinds	Truck speed limit based on digital input (switch inside the cabin)
Cabin pre-heater	Cyclonic engine air pre-cleaner
Rear view and/or front view camera systems and monitor	Linde Load Weight Indicator (+/- 22 lbs)
Back-up camera option	Custom Paint
Air Ride seats	Triple Mast
Gated lever - additional hydraulic service	
External step lighting	

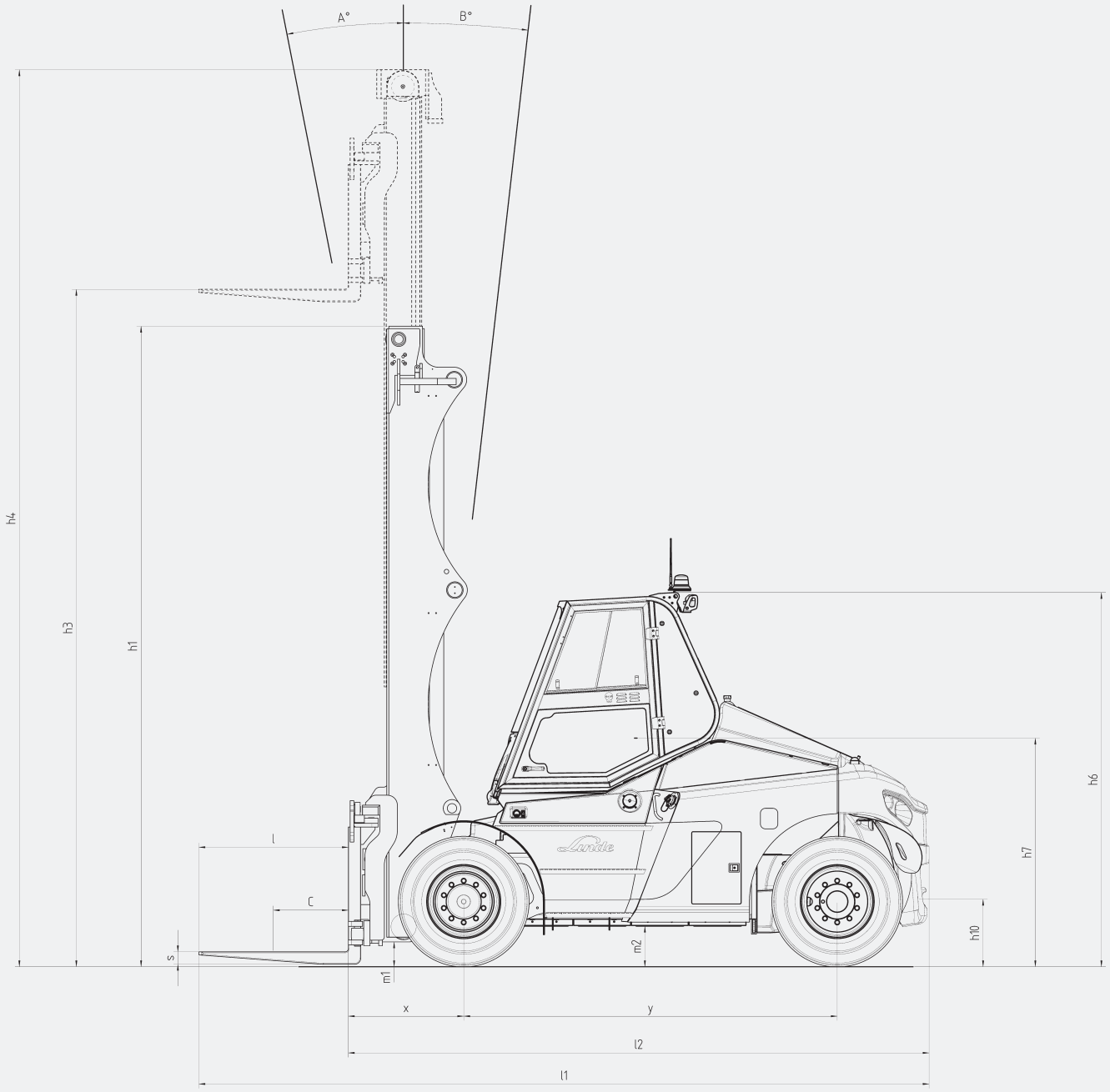
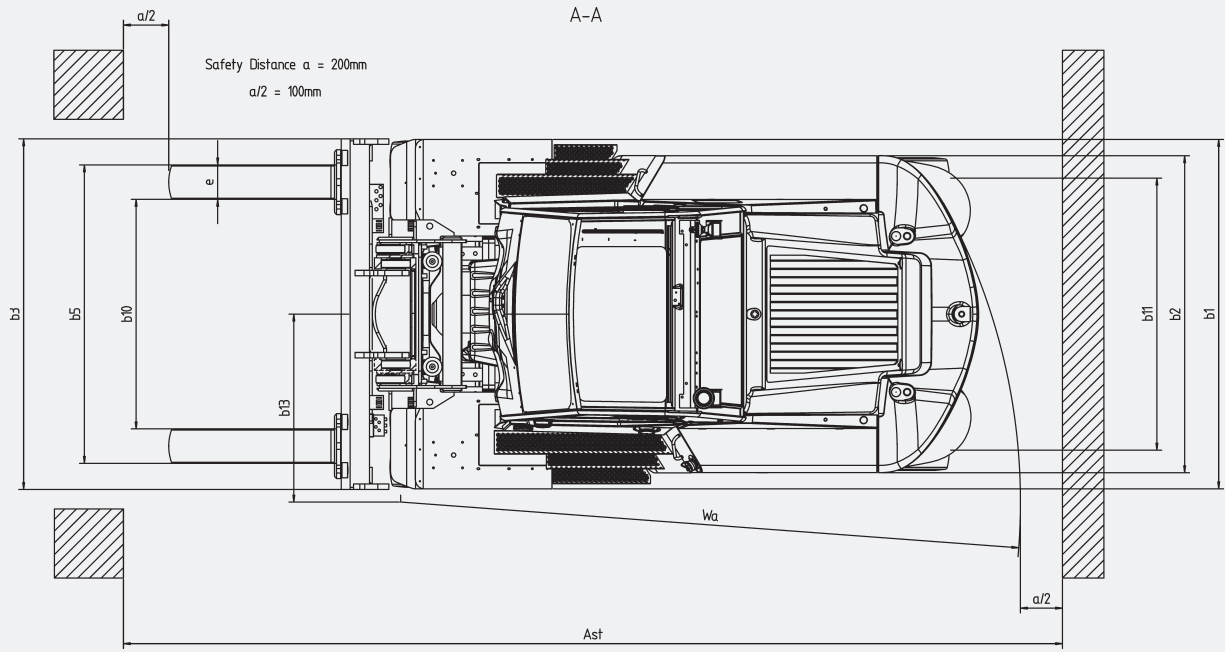

Capacity*

1411 Series HT100Ds/600 - HT120Ds/600		Capacity (lb.) @ 24" Load Center ⁴								Tires: Dual Pneu 10x20/16 PR ⁴				Forks 3.5 x 7.8 x 55.1" ³			
Mast	HT100Ds/600	22000	22000	22000	22000	22000	22000	20815	19720	22000	22000	22000	22000	22000	22000	20815	19720
Mast	HT120Ds/600	26000	26000	26000	26000	26000	26000	24980	23665	26000	26000	26000	26000	26000	26000	24980	23665
Type	Simple / Dual / Triple	Simple	Simple	Simple	Simple	Simple	Simple	Simple	Simple	Dual	Dual	Dual	Dual	Dual	Dual	Dual	Dual
h1	Height of mast, lowered	121.5	131.5	141.0	151.0	161.0	170.5	180.5	190.5	126.0	136.0	146.0	155.5	165.5	175.5	185.0	195.0
h2	Free lift	0	0	0	0	0	0	0	0	64.0	74.0	83.5	93.5	103.0	113.0	123.0	132.0
h3	Lift	138.0	157.5	177.0	196.5	216.5	236.0	256.0	275.5	138.0	157.5	177.0	196.5	216.5	236.0	256.0	275.5
h4	Height of mast, extended	190.5	210.0	230.0	249.5	269.0	289.0	308.5	328.0	200.0	220.0	239.5	259.5	279.0	298.5	318.5	338.0
Forks ³	Tilt forward / back	15/10	15/10	15/10	15/10	15/10	15/10	15/10	15/10	15/10	15/10	15/10	15/10	15/10	15/10	15/10	15/10

1411 Series HT140Ds/600 - HT150Ds/600 - HT160Ds/600 - HT180Ds/600		Capacity (lb.) @ 24" Load Center ⁴								Tires: Dual Pneu 12x20/20 PR ⁴				Forks 3.9 x 7.9 x 55.1" ³			
Mast	HT140Ds/600	31000	31000	31000	31000	31000	31000	29175	27640	31000	31000	31000	31000	31000	31000	29175	27640
Mast	HT150Ds/600	33000	33000	33000	33000	33000	33000	31260	29615	33000	33000	33000	33000	33000	33000	31260	29615
Mast	HT160Ds/600	35000	35000	35000	35000	35000	35000	33340	31585	35000	35000	35000	35000	35000	35000	33340	31585
Mast	HT180Ds/600	40000	40000	40000	40000	40000	40000	0	0	40000	40000	40000	40000	40000	40000	0	0
Type	Simple / Dual / Triple	Simple	Simple	Simple	Simple	Simple	Simple	Simple	Simple	Dual	Dual	Dual	Dual	Dual	Dual	Dual	Dual
h1	Height of mast, lowered	134.5	144.5	154.0	164.0	174.0	183.5	193.5	203.5	134.5	144.5	154.0	164.0	174.0	183.5	193.5	203.5
h2	Free lift	0	0	0	0	0	0	0	0	69.0	79.0	89.0	98.5	108.0	118.0	128.0	138.0
h3	Lift	138.0	157.5	177.0	196.5	216.5	236.0	256.0	275.5	138.0	157.5	177.0	196.5	216.5	236.0	256.0	275.5
h4	Height of mast, extended	203.5	223.0	243.0	262.5	282.0	302.0	321.5	341.0	203.5	223.0	243.0	262.5	282.0	302.0	321.5	341.0
Forks ³	Tilt forward / back	15/10	15/10	15/10	15/10	15/10	15/10	15/10	15/10	15/10	15/10	15/10	15/10	15/10	15/10	15/10	15/10

1411 Series HT100Ds/1200 - HT120Ds/1200		Capacity (lb.) @ 48" Load Center ⁴								Tires: Dual Pneu 12x20/20 PR ⁴				Forks 3.9 x 7.9 x 94.5" ³			
Mast	HT100Ds/1200	22000	22000	22000	22000	22000	22000	22000	22000	22000	22000	22000	22000	22000	22000	22000	22000
Mast	HT120Ds/1200	26000	26000	26000	26000	26000	26000	24950	23635	26000	26000	26000	26000	26000	26000	24950	23635
Type	Simple / Dual / Triple	Simple	Simple	Simple	Simple	Simple	Simple	Simple	Simple	Dual	Dual	Dual	Dual	Dual	Dual	Dual	Dual
h1	Height of mast, lowered	134.5	144.5	154.0	164.0	174.0	183.5	193.5	203.5	134.5	144.5	154.0	164.0	174.0	183.5	193.5	203.5
h2	Free lift	0	0	0	0	0	0	0	0	69.0	79.0	89.0	98.5	109.0	119.0	128.0	138.0
h3	Lift	138.0	157.5	177.0	196.5	216.5	236.0	256.0	275.5	137.0	157.0	177.0	196.5	216.5	236.0	255.5	275.5
h4	Height of mast, extended	203.5	223.0	243.0	262.5	282.0	302.0	321.5	341.0	203.5	223.0	243.0	262.5	282.0	302.0	321.5	341.0
Forks ³	Tilt forward / back	15/10	15/10	15/10	15/10	15/10	15/10	15/10	15/10	15/10	15/10	15/10	15/10	15/10	15/10	15/10	15/10

1411 Series HT140Ds/1200 - HT150Ds/1200 - HT160Ds/1200 - HT180Ds/900		Capacity (lb.) @ 36/48" Load Center ⁴								Tires: Dual Pneu 12x20/20 PR ⁴				Forks 3.9 x 9.8 x 94.5" ³ / 3.9 x 9.8 x 71" ³			
Mast	HT140Ds/1200	31000	31000	31000	31000	31000	31000	28990	27460	31000	31000	31000	31000	31000	31000	28990	27460
Mast	HT150Ds/1200	33000	33000	33000	33000	33000	33000	33000	33000	33000	33000	33000	33000	33000	33000	33000	33000
Mast	HT160Ds/1200	35000	35000	35000	35000	35000	35000	33235	31390	35000	35000	35000	35000	35000	35000	33235	31390
Mast	HT180Ds/900	40000	40000	40000	40000	40000	40000	0	0	40000	40000	40000	40000	40000	40000	0	0
Type	Simple / Dual / Triple	Simple	Simple	Simple	Simple	Simple	Simple	Simple	Simple	Dual	Dual	Dual	Dual	Dual	Dual	Dual	Dual
h1	Height of mast, lowered	134.5	144.5	154.0	164.0	174.0	183.5	193.5	203.5	134.5	144.5	154.0	164.0	174.0	183.5	193.5	203.5
h2	Free lift	0	0	0	0	0	0	0	0	69.0	79.0	89.0	98.5	109.0	119.0	128.0	138.0
h3	Lift	138.0	157.5	177.0	196.5	216.5	236.0	256.0	275.5	138.0	157.5	177.0	196.5	216.5	236.0	256.0	275.5
h4	Height of mast, extended	203.5	223.0	243.0	262.5	282.0	302.0	321.5	341.0	203.5	223.0	243.0	262.5	282.0	302.0	321.5	341.0
Forks ³	Tilt forward / back	15/10	15/10	15/10	15/10	15/10	15/10	15/10	15/10	15/10	15/10	15/10	15/10	15/10	15/10	15/10	15/10

**Capacity ratings can be affected by changing forks, load center, and/or drive tires.

Downrating Charts*

Reference pneumatic tires with Linde integral sideshifting/fork positioning carriage and forks.

HT100Ds/600 (Simple Mast)

Load Center Lifting Capacity Diagram

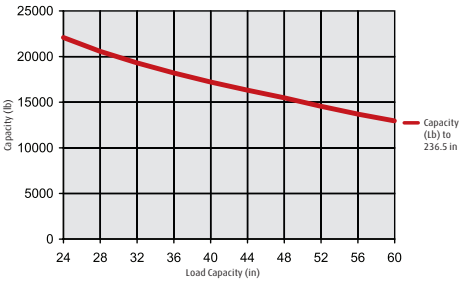

HT120Ds/600 (Simple Mast)

Load Center Lifting Capacity Diagram

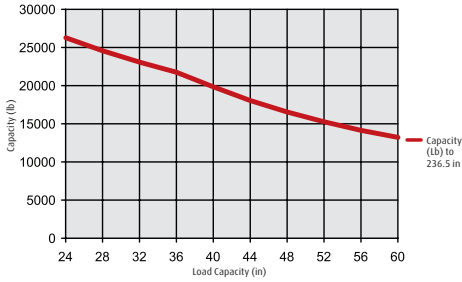

HT140Ds/600 (Simple Mast)

Load Center Lifting Capacity Diagram

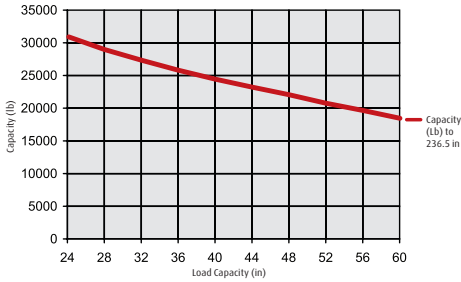

HT150Ds/600 (Simple Mast)

Load Center Lifting Capacity Diagram

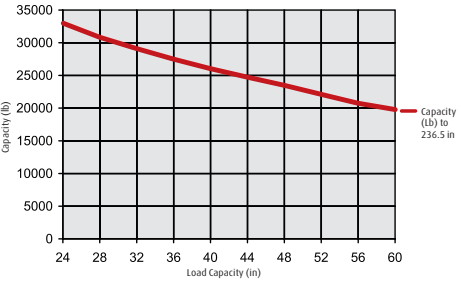

HT160Ds/600 (Simple Mast)

Load Center Lifting Capacity Diagram

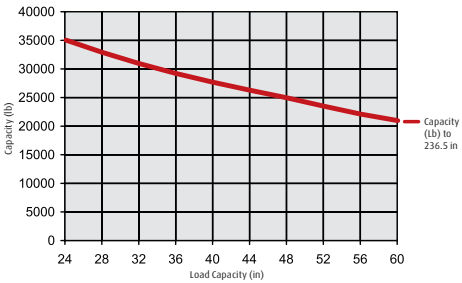

HT180Ds/600 (Simple Mast)

Load Center Lifting Capacity Diagram

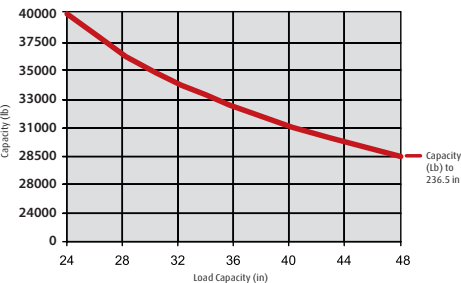

HT100Ds/1200 (Simple Mast)

Load Center Lifting Capacity Diagram

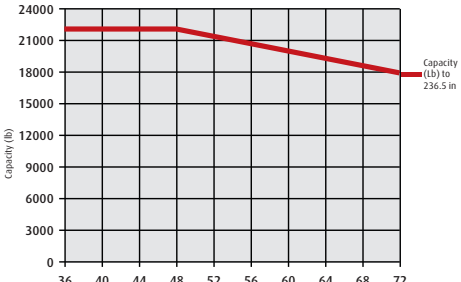

HT120Ds/1200 (Simple Mast)

Load Center Lifting Capacity Diagram

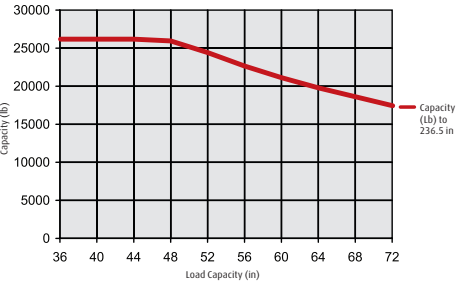

HT140Ds/1200 (Simple Mast)

Load Center Lifting Capacity Diagram

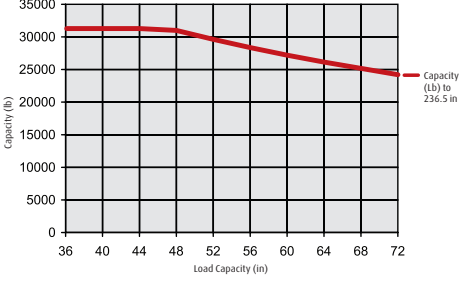

HT150Ds/1200 (Simple Mast)

Load Center Lifting Capacity Diagram

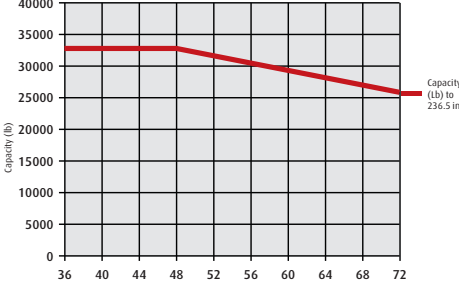

HT160Ds/1200 (Simple Mast)

Load Center Lifting Capacity Diagram

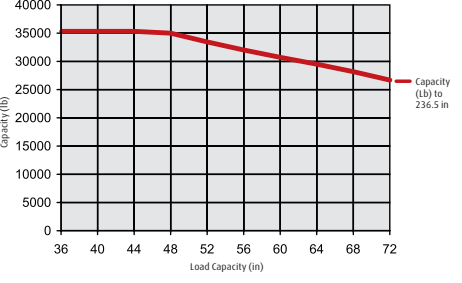

HT180Ds/900 (Simple Mast)

Load Center Lifting Capacity Diagram

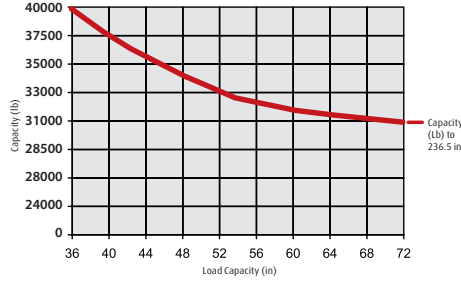

* For quick reference only, contact factory for detailed ratings.

Features

Modern, powerful engines

- Modern, durable and fuel-efficient Detroit Diesel engines
- Detroit/MTU 173HP 201HP ratings incorporating selective catalytic reduction
- Opt. 228HP engine
- 66.0 gallon fuel tank
- 5.0 gallon DEF tank



Reliable/Durable equipment

- Quality components which have been thoroughly tested for durability and secure operation
- Variable displacement piston pump and CanBus actuated control valves
- Kessler Drive Axles
- ZF Transmissions
- Heavy Duty masts and carriages

Precise operation

- Power on Demand
- Linde Load Control (LLC)
- Precise load handling and powerful acceleration

Linde Service Monitoring System (SMS)

- Optimized Total Cost of Ownership due to real time monitoring of total engine hours, idle time, static working hours and mobile working hours
- Best in class maintenance intervals
- Best in class engine oil change at 750hr intervals

Linde Carriage Options

- Fully independent side shift carriage
- Self levelling carriage for uneven surfaces and long loads
- Integral carriage with side shift and fork positioning



Operator's compartment

- Maximized comfort cab and adjustable steering column
- Standard 7" High Resolution Color LCD Display with rotary multi-function interface"



Forward Tilt Cab

- Major components can be reached rapidly and easily by tilting the cab forward
- Maximized access is possible by tilting the engine cooling system, allowing engine and transmission removal as a single unit
- Easy service access from both sides of the truck



Unique all-around visibility

- Excellent through the mast visibility due to an optimized seating position
- The Armored Glass roof section provides excellent visibility of the elevated load
- Superb rear visibility guaranteed by wide rear window and the unique Linde "Clear View" deck incorporating a flush mounted cooling system and the Porsche designed counterweight

For more information on Linde material handling equipment, please contact:

KION North America Corporation
 2450 West 5th North Street, Summerville, SC 29483
 Phone: (843) 875-8000 Truck Sales Fax: (843) 875-8471
 E-mail: trucksales.na@kiongroup.com
 www.kion-na.com



ANSI Standard truck meets all applicable mandatory requirements of ANSI/ITSDF B56.1 standards for powered industrial trucks.
 NOTE: Performance data may vary due to motor and system efficiency tolerances. The performance depicted represents nominal values obtained under typical operating conditions. Metric dimensions are in millimeters unless otherwise specified. All metric dimensions are not direct equivalents due to rounding data. The descriptions and specifications included on this data sheet were in effect at the time of printing. Linde Material Handling North America Corporation reserves the right to make improvements and changes in specification or design without notice and without incurring obligation. Please check with your authorized Linde dealer for information on possible updates or revisions.

linde_spec_1411_0916
 USA_v13.2_091516-0730A